



**WAUPACA
ELEVATOR COMPANY, INC.**



Residential Elevators

Waupaca Elevator

Since 1957, Waupaca Elevator has built safety, quality, value, and choice into the manufacture of residential elevators.

Waupaca Elevator is a leader in producing residential elevators for the US... first to provide UL and UL listed elevator control panels, tape reader selectors

on roped hydraulic units, and first use of performance enhancing variable speed controls on winding drum elevators.

Incorporated in Waupaca, Wisconsin; Waupaca Elevator began manufacturing screw-drive residential elevators and dumbwaiters. Drive systems soon



Designer

A popular and versatile model for those wishing to create or decorate their own car interior. This car features unfinished flush birch walls and ceiling, solid wood handrail, brushed finish stainless or muntz stations, unfinished floor, dual 4" recessed down lights with white trim rings, and a basic selection of vinyl-lam accordion gates. The Designer is also available in other wood veneers as well as a broad choice of applied laminates.



Heritage

A new look with timeless beauty, this model features textured neutral wall panels and ceiling with handcrafted hickory hardwood trim, solid wood handrail, brushed finish stainless steel or muntz stations, unfinished floor, dual 4" recessed down lights with white trim rings, and a basic selection of vinyl-lam accordion gates. The hickory trim is provided in natural finish only.

evolved to winding-drum and roped hydraulics. The company moved to a larger location in Appleton, Wisconsin in 1997. After outgrowing the new location by 2002, a move to a modern 355,000 sq. ft. facility situated on 21 acres assures ample space for growth. Waupaca Elevator pursues the best technology and efficiencies to enhance the personal convenience and affordability of its residential elevators. In new home construction or remodeling, “Specify the Specialists” — Waupaca Elevator.



Estate

This distinctly crafted and hand finished model features oak wall panels and hardwood trim, textured neutral ceiling, solid wood handrail, brushed finished stainless steel or muntz stations, unfinished floor, dual 4” recessed down lights with white trim rings, and a basic selection of vinyl-lam accordion gates. The oak walls and trim may be finished natural, medium, dark or left unfinished. The Estate is also available in walnut or cherry wood with natural finish or left unfinished.



Estate Ltd.

This elegant, fine quality car features a hand finished cherry interior accented with polished brass fixtures. The walls and ceiling are trimmed with cherry hardwood and highlighted with our own blended finish. Natural finish and unfinished are also available. This model includes a matching handrail, kick plate and stations. Also included are four 4” recessed down lights with brass trim rings, an arched valance and unfinished floor. A clear or smoked acrylic accordion gate is standard.

Custom



Custom Cars

A vast array of materials, styles, fixtures, and features allow you... the homeowner the opportunity to create a design uniquely your own.

We have selected an option list of the finest materials available to provide utility, elegance, value and comfort.

"Waupaca Elevator and our dealer exceeded our expectations in designing and building the perfect elevator to fit into our new home. My husband and I were extremely delighted with the whole process."

– Ferill Jeane
Little Chute, Wisconsin



Raised Panel Solid Wood Cars

Our solid hardwood cars may be constructed from our standard woods or an exotic wood of your choice depending on availability. We have compiled 10 configurations of standard option panel designs. Custom designs and treatments may be considered from your drawings. Combinations of wood species offer beautiful contrast and truly unique designs.

Raised panel cars include choice of brushed or polished fixtures in stainless steel or muntz, with matching handrail. Coordinating trim rings on quad lights, matching kick plate and a clear or smoked vision panel car gate complete the standard option list.

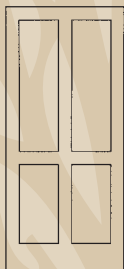

4-panel

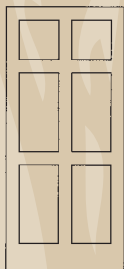

6-panel

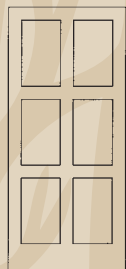

6-panel
symmetri-
cal

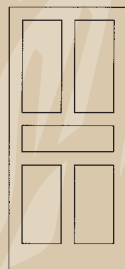

5-panel



6-panel
special



Arched
4-panel

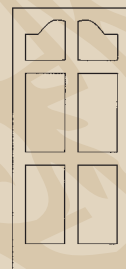

Arched
6-panel



Arched
6-panel
symmetri-





Arched
5-panel



Arched
6-panel
special

QUALITY

Waupaca Elevator products reflect our dedication to innovation and superior quality. Custom handcrafted car interiors reflect “select or better” lumber and top grade materials used by our experienced wood workers. Our  and  electrical shop produces tested and proven controls. Our vendors are chosen with quality, stability and service in mind.





VARIETY

Waupaca Elevator offers one of the broadest selections of car models. We also allow you the option of designing a custom car and fixtures within code constraints for size and capacity. A variety of custom blended or Minwax stains and finishes may be selected to protect and enhance your design. From budget conscious basics, to the quest for opulence, it's your choice!

AVAILABILITY

Our nationwide authorized dealer network can assist with design, code compliance in your locale, installation and continuing service. Waupaca supports our valued dealer network with technical and sales support, documentation and warranties. Our leading edge facility and trained employees assure reasonable lead times and superior quality.

SAFETY

Safety is paramount at Waupaca Elevator. All of our elevators are designed to comply with the requirements of the National Electrical Code, ASME A17.1-2000 Part 5.3 with addenda standard for residential elevators, and most State and Local building codes. Standard safety features include a  and  elevator control panel, emergency stop switch, emergency alarm, telephone jack,  hoistway door locking device,  gate safety switch, broken / slack cable safety device and emergency lowering capability.

WARRANTY

Your investment in a Waupaca elevator is secure with a [two year limited warranty](#) against defects in material or workmanship. Warranty labor is provided with the duration to be established by your authorized dealer. With proper maintenance, your elevator will provide many years of trouble free utility, convenience and value.

Features

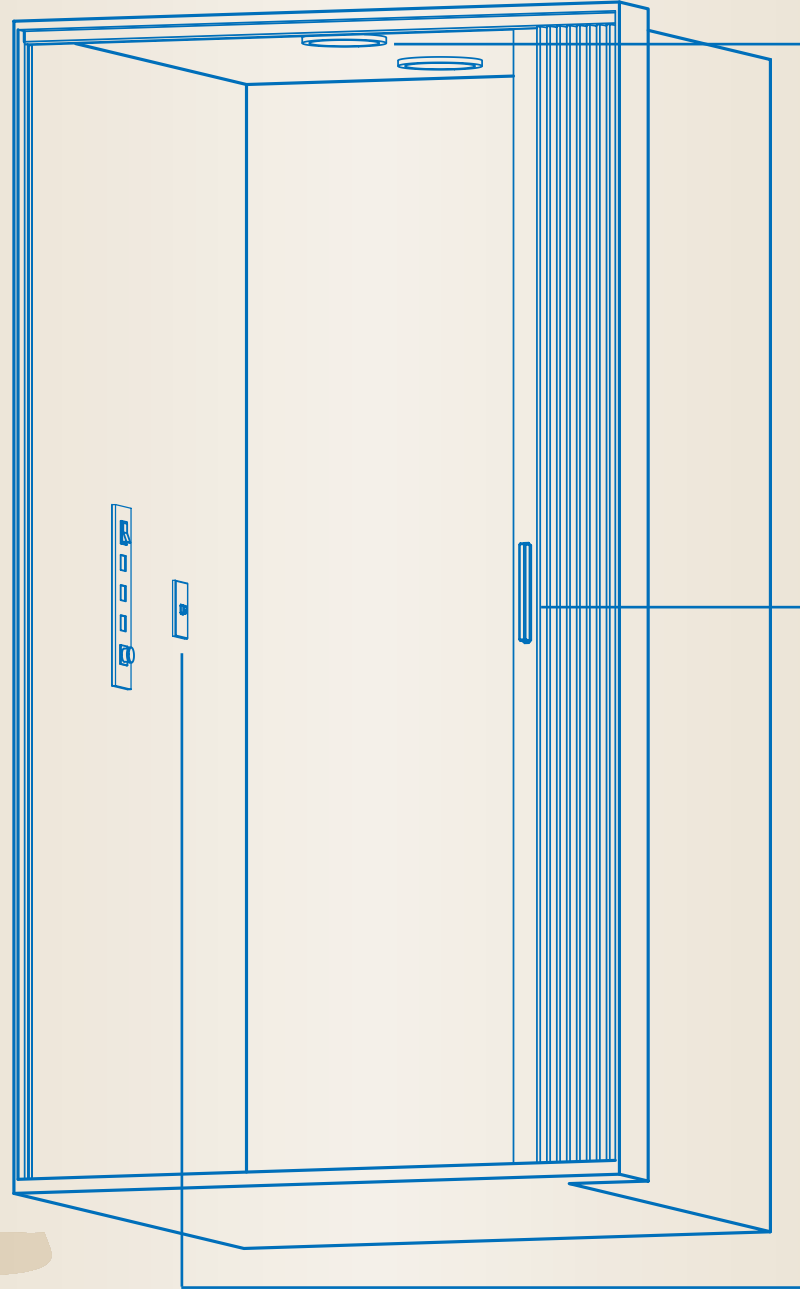

Car walls are available in Oak, Walnut, Birch, Cherry, textured neutral panels and special order woods. Finishes include natural, medium, dark or unfinished. Melamine wall options are white and light wood grain finishes, Over 100 applied laminate choices are available.

All cars feature **recessed down lighting**. Down lights are available in a choice of white, black, chrome or brass trim rings. Cars may be ordered minus factory lighting fixtures to allow field installation of custom lighting that will match your home décor. PLC equipped elevators include automatic lighting and homing capability.

Ceilings are available in flush wood or trimmed panels to match your car walls. Textured neutral panels, melamine, and applied laminates are also available to enhance your decorating options.

Accordion gates are provided in four standard vinyl-lam options. Smoked or clear acrylic see-through panels are an upgrade option. A power gate operator option (available only on accordion gate equipped elevators with PLC controls) adds safety and convenience. Scissors style gates in four color choices are available only as an option.

All cars are provided with an unfinished plywood floor, This feature allows for flexibility in applying carpet or other materials within weight limitations to suit your needs.

Car designs feature assembly methods and materials to assure a solid, quiet and secure environment while riding in your elevator car.

A code required **phone jack** for wall mounting is standard on every Waupaca elevator. An optional recessed phone box enhances style. With the phone box, your phone is hidden behind a swing open panel of matching wood, muntz or stainless steel.



Door Interlocks – EMI or GAL

Prevent operation of elevator with door open and prevent opening of any door when car is not at designated landing. feature extended service life LEDs.



Add convenience and resale value to your new or existing home.

Design Your Own



black

white



Handrails

Standard wood handrails to match your car walls add an element of safety and security to the ride of your elevator. Optional brushed or polished finish handrails are also available.

Hall Stations

Hall stations are available in finishes to match car operating panels. They include a call button with an In-Use indicator. A separate Car-Here indicator light button is available. Key locks may be added to all controls for controlled access and safety. Hall stations feature extended service life LEDs.

Car Operating Panels

Car operating panels are available in brushed muntz or stainless steel as standard with a polished finish as optional. The large buttons illuminate when pressed, to indicate a registered call. An emergency stop switch and an alarm button are provided for your safety. A car light switch is included for convenience. Car operating panels feature extended service life LEDs.



Down Light Trim Rings



chrome



brass



Options

Wood Finishes

Waupaca Elevator has traditionally offered unfinished wood products and featured our own signature stained or natural oil rubbed finish. Offerings now include lacquer resilient coatings and Minwax stains applied to selected wood products.

Those who wish to match other wood treatments in their homes may select unfinished cars. Your millwork or design professional may then match the nuances of complimenting décor.



wood



muntz



stainless steel

Phone Boxes



Bird's Eye Maple



Maple



Alder

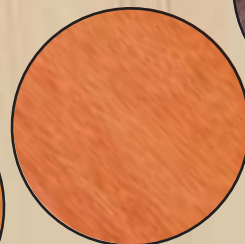

Mahogany

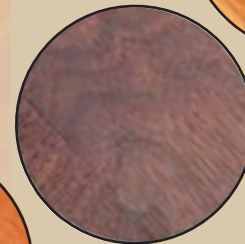

Walnut



Hickory



Cherry



Oak

Gates

STANDARD LIGHT OAK

OPTIONAL BRONZE ACRYLIC

STANDARD WHITE

OPTIONAL CLEAR ACRYLIC

STANDARD NATURAL OAK

OPTIONAL 3 PANEL CLEAR ACRYLIC

STANDARD CHALK

OPTIONAL 3 PANEL BRONZE ACRYLIC

Close Up



power gate operator

Gates

Accordion gates are standard on all cars. Our wide selection of standard vinyl lam finishes included light oak, white, natural oak and chalk. Optional accordion gates feature clear or bronze acrylic see through panels. Special order accordion gates are also available.

CUSTOM-LIFT® WINDING DRUM STANDARD SPECIFICATIONS

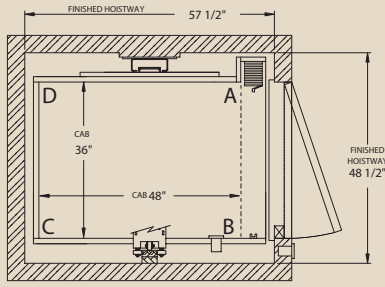

- CAPACITY -500LB.
- TRAVEL -up to 50 ft.
- SPEED- 30 feet per minute
- OVERHEAD -96" above top finished floor with standard 7' car (additional overhead required with some options and configurations).
- GUIDE RAIL -3/16" precision formed steel channel
- MOTOR- single speed, 2HP, instant reversing
- GEARBOX -high- ratio, direct mounted and coupled
- DRUM- single drum with outboard bearing
- BRAKE- spring applied, electrically released
- TRUCK- heavy gauge steel with hi-density synthetic guides and rollers
- SAFETIES -twin instantaneous, broken rope and slack rope applied by a retained compression spring.
- SUSPENSION- two 1/4" 7x19 Wire Rope
- POWER REQUIREMENTS:
 - 230 volt, 30 AMP, single phase, 60 hertz.
 - 208 volt, single phase supply requires a power boost transformer
 - A separate 115-volt, 15 AMP circuit is required for car lighting
- CONTROLS -Push button automatic at car and landings, car light switch, in-car emergency stop switch, in-use indicator in hall stations
- SIGNAL SYSTEM -wall mount modular phone jack, emergency alarm button in car operating panel
- HOISTWAY DOOR INTERLOCKS EMI® or GAL Type "N" required at each opening.
- EMERGENCY LOWERING -manual lowering device

WINDING DRUM OPTIONS

- EASY RYDE – Waupaca's name for VVVF Motor control that allows seamless starts, stops, and quiet run
- CAR CHOICES - Some restrictions on 500 lb capacity units, all car styles, including raised panel wood cars are available.
- SHEAVES - Various sheave arrangements are available to accommodate most machine room configurations.
- PLC BASED CONTROLLER WITH TAPE READER – allows automatic car lighting and homing feature.
- BATTERY OPERATED EMERGENCY LIGHT AND ALARM
- CAPACITY 750LB. CAR SIZE - Up to 12 sq. ft. net platform area.
- CAPACITY 1,000 LB. CAR SIZE - Up to 15 sq. ft. net platform area
- SPEED - 40 feet per minutes
- WIRE ROPES 3/8" x 8x19 Standard
- BATTERY LOWERING or round trip battery option available
- PLC BASED CONTROLLER WITH TAPE READER – allows automatic car lighting and homing feature.
- IN-HOISTWAY OVERHEAD MOUNTED DRIVE AVAILABLE – contact dealer or manufacturer for details.

EXCELEVATOR™ HYDRAULIC SPECIFICATIONS

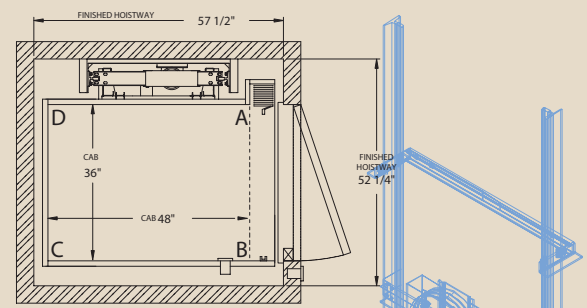

- CAPACITY - 750 LB. with CAR SIZE - up to 12 sq. ft. net
- CAPACITY - 950 LB. with CAR SIZE - up to 15 sq. ft. net
- TRAVEL -up to 50 ft.
- STOPS -up to 6 stops
- SPEED -40 feet per minute
- PIT DEPTH -8" minimum pit required
- OVERHEAD -8'-4" above top finished floor with standard 7' car (additional overhead required with some options and configurations)
- GUIDE RAIL -#8 machined elevator T-rail
- PUMP UNIT -rotary screw type with submersed motor.
- MOTOR - 2.5HP. 208/230/1PH – single speed
- VALVE – Adjustable 2 speed
- ELECTRIC REQUIREMENTS -208/ 230 volts, 30 AMP single phase, 60 hertz
- A separate 115-volt 15 AMP circuit is required for car lighting.
- CAR FRAME -full height with synthetic guide rollers.
- SAFETIES -twin instantaneous type "A" slack rope safety.
- SUSPENSION -two 3/8" 8x19 wire ropes.
- CONTROLS -Push button automatic at car and landings, car light switch, in-car emergency stop switch; emergency alarm button, in-use indicator in hall stations.
- Ⓛ Controller is PLC based.
- SIGNAL SYSTEM -wall-mount modular phone jack, emergency alarm button on car operating panel.
- HOISTWAY DOOR INTERLOCKS EMI® or GAL Type "N" required at each opening.
- EMERGENCY LOWERING – Floor selectable descent with battery back-up power supply.
- PROGRAMMABLE HOMING FEATURE

HYDRAULIC OPTIONS

- CAR CHOICES -all car styles available.

Car Options

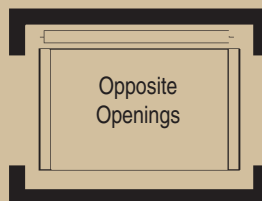
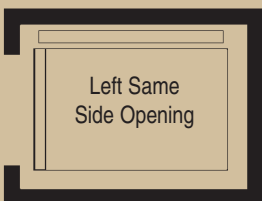

Living...



Place

We all live somewhere, Luxurious homes on spacious grounds, town homes in comfortable neighborhood surroundings, condominiums where maintenance is provided in a cozy space. [Waupaca Elevator Company, Inc.](#) has an elevator for your **Place!**

Lifestyle

Lifestyles vary significantly across age and social demographics. The common thread is that we are all advised that staying active, mobile, and engaged in life benefits our physical and social well-being. [Waupaca Elevator Company, Inc.](#) products enable an active **Lifestyle** in and out of places we live!

Quality

Is a virtue in everything that we do, think, and pursue whether tangible or intangible. Quality is an integral part of the products we buy, the services we procure, food we consume, and our interactions with our peers, family, and customers. [Waupaca Elevator Company, Inc.](#) is a standard bearer for **Quality** in residential elevators and dumbwaiters!

Choice

As a long-established and recognized leader in the home elevator industry, Waupaca Elevator Company, Inc. has consistently brought choice and value to their customers. From elaborately customized cars with exotic wood and materials to the attractive but basic veneer walled car, drive system alternatives, car sizes and configurations, as well as amenities, may be chosen to meet your lifestyle. [Waupaca Elevator Company, Inc.](#) offers you **Choice!**

Value

Is considered to be the performance, function, or utility that is received in exchange for a price. Our highest value is placed on safety. Above all the product must be safe! Other attributes are quality, price, flexibility in design, and integrity in service. [Above all, Waupaca Elevator Company, Inc.](#) is **Value!**



Your Authorized Waupaca Elevator Dealer:



**WAUPACA
ELEVATOR COMPANY, INC.**

1726 North Ballard Rd. Appleton, Wisconsin 54911
1-800-238-8739
website: www.waupacaelevator.com

All information within is subject to change without advance notice